

SMIT series

■ Outline Drawing

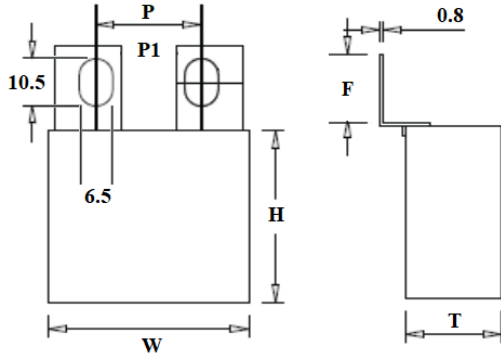

■ Typical Applications

These capacitors are used in high voltage, high current

And high pulse applications such as :

IGBT protection circuits

Snubber networks

Energy conversion and control in power electronics

Protection circuits in SMPS

■ Features

Double sided metalized polypropylene film

Small structure loss

Small internal temperature rise and

excellent Flame retardancy

Flame retardant UL94 - V0, RoHS compliant

■ Specifications

■ Construction



Reference Standard	IEC 61071				
Climatic Category	40/105/56/B				
Operating Temperature Range	85°C for UR (dc) ; 75°C for UR (ac)				
Capacitance Range	0.047 μ F ~ 9.0 μ F				
Rated (DC) Voltage	630V	700V	850V	1000V	1200V
	1600V	2000V	2500V	3000V	
Capacitance Tolerance	\pm 5%(J) 、 \pm 10%(K)				
Voltage Proof	1.6UR (10s)				
Dissipation Factor	\leq 0.2% (25°C, 1kHz)				
Insulation Resistance	IR \geq 15,000M Ω (25°C, 100V, 1min)				

SMIT series

■ Product code system

SMIT	F	205	K	0700	D	1	26	DP
Type	Internal use	Capacitance	Tolerance	Rated Voltage	Voltage	Lead forming	Lead Pitch	Lead Length
SMIT= IGBT Snubber Capacitors (Boxed)	--	473 =47000pF =47nF =0.047μF	J=±5% K=±10% M=±20%	0630=630Vdc 0700=700Vdc 1000=1000Vdc 1600=1600Vdc 2000=2000Vdc	D=DC A=AC	Shown as Table I	26=26mm 35=35mm 40=40mm	DP= Flat quick-connectors

■ Table I

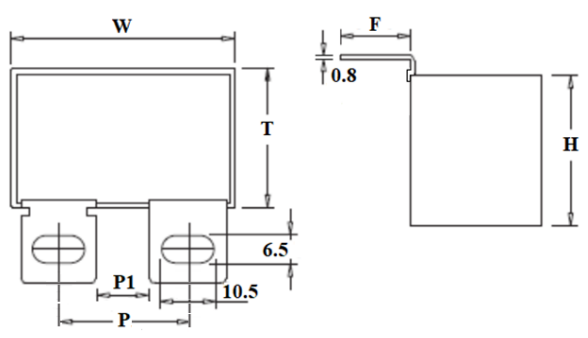
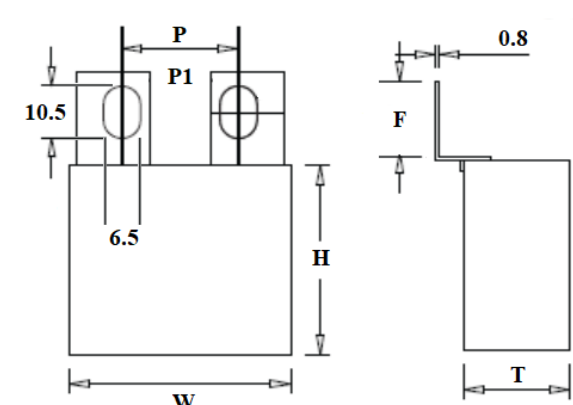
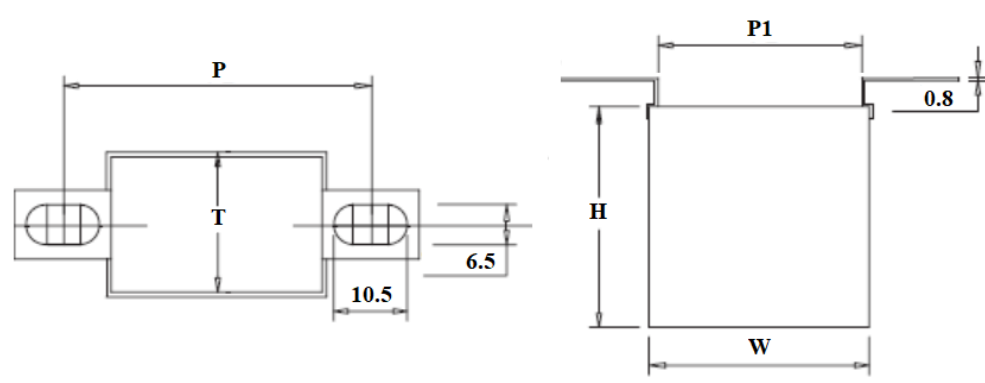
Style	1	2
Lead Forming		
Style	3	
Lead Forming		

SMIT series (Direct Mounting)

■ Dimensions (mm)

630V/700V/850Vdc (420V/420V/450Vac)							
Cap. μF	W	H	T	dv/dt (v/us)	ESR (MΩ) @100KHz	Ls (nH)	I _{max} 100KHz @70°C (A)
0.68	37	25	15	950	5	21	14
1.0	37	30	16	950	5	21	14
1.2	37	30	16	950	4.3	21	16
1.5	37	34	20	950	4.3	21	16
1.8	37	34	20	950	4.3	21	18
2.0	42	40	20	700	3.8	27	18
2.2	42	40	20	700	3.8	27	19
2.5	42	40	20	700	3.8	27	19
3.0	42	44	24	700	3.8	27	20
3.3	42	44	24	700	3.3	27	20
4.0	42	44	24	700	3.3	27	22
4.7	42	45	30	700	3.3	27	22
5.0	42	45	30	700	2.7	27	23.5
6.0	42	43	42	700	2.7	27	25
6.5	42	43	42	700	2.7	27	26
6.5	57	45	30	400	2.3	31	25
7.0	57	45	30	400	2.3	31	26
8.0	57	50	35	400	2.3	31	27
9.0	57	50	35	400	2.3	31	30

1000V/1200Vdc (500V/600Vac)							
Cap. μF	W	H	T	dv/dt (v/us)	ESR (MΩ) @100KHz	Ls (nH)	I _{max} 100KHz @70°C (A)
0.47	37	25	15	1400	4.7	22	15
0.47	32	29	19	1800	4.2	14	21
0.68	37	30	16	1400	4.7	22	15
0.82	37	30	16	1400	4.7	22	17
1.0	42	50	20	1400	4.5	22	17
1.2	37	34	20	1400	4.5	22	17
1.2	42	40	20	900	4.5	27	17
1.5	42	40	20	900	4.5	27	17
1.5	42	50	20	900	4.5	27	17
2.0	42	44	24	900	3.8	27	21
2.2	42	44	24	900	3.8	27	21
2.5	42	45	30	900	3.8	27	22
3.0	42	45	30	900	3.8	27	20
3.3	42	43	42	900	3.8	27	21
3.3	57	45	30	600	3.8	30	21
4.0	57	45	30	600	3.8	30	22
4.7	57	50	35	600	3.8	30	23
5.0	57	50	35	600	3.8	30	25

SMIT series (Direct Mounting)

■ Dimensions (mm)

1600Vdc (650Vac)							
Cap. μF	W	H	T	dv/dt (v/us)	ESR (MΩ) @100KHz	Ls (nH)	I _{max} 100KHz @70°C (A)
0.22	37	25	15	1900	5.8	22	15
0.33	37	30	16	1900	5.8	22	15.5
0.39	37	34	20	1900	5.3	22	16
0.47	37	34	20	1900	5.3	22	17
0.68	42	40	20	1300	3.8	27	18
0.82	42	44	24	1300	3.8	27	19
1.0	42	45	30	1300	3.8	27	19.5
1.2	42	45	30	1300	3.8	27	20
1.5	42	43	42	1300	3.8	27	21
1.5	57	45	30	800	3.2	31	22
2.0	57	50	35	800	3.2	31	24

2500V/3000Vdc (750V/800Vac)							
Cap. μF	W	H	T	dv/dt (v/us)	ESR (MΩ) @100KHz	Ls (nH)	I _{max} 100KHz @70°C (A)
0.047	37	25	15	3350	8.3	22	13
0.068	37	25	15	3350	8.3	22	14
0.10	37	30	16	3300	8	22	15
0.15	37	34	20	3300	7.3	22	16
0.18	37	34	20	3300	3.8	22	17
0.22	42	40	20	2200	3.8	27	17
0.33	42	44	24	2200	3.3	27	17.5
0.47	42	45	30	2200	3.3	27	18
0.68	42	43	42	1500	3.3	27	18.5
0.68	57	45	30	1500	3.3	31	19
0.82	57	50	35	1500	3.3	31	20
1.0	57	50	35	1200	3.3	31	21

2000Vdc (700Vac)							
Cap. μF	W	H	T	dv/dt (v/us)	ESR (MΩ) @100KHz	Ls (nH)	I _{max} 100KHz @70°C (A)
0.10	37	25	15	2250	8	22	14
0.15	37	25	15	2250	8	22	15
0.22	37	30	16	2250	5.8	22	15.5
0.33	37	34	20	2250	5.8	22	16
0.47	42	40	20	1400	3.8	27	17
0.56	42	44	24	1400	3.8	27	18
0.68	42	44	24	1400	3.3	27	18.5
0.82	42	45	30	1400	3.3	27	19
1.0	42	43	42	1400	3.3	27	21
1.0	57	45	30	900	3.8	32	24
1.2	57	45	30	900	3.8	32	24
1.5	57	50	35	900	3.8	31	25

SMIT series

■ Specifications

Test items	Performance	Test Method
Withstand voltage (Between Terminals)	Shall be no abnormality	160% of rated voltage, 10sec
Between terminal and Enclosure	Shall be no abnormality	UR×200%+1000Vac, 60sec.
Insulation resistance (Between Terminals)	$C_R \leq 0.33\mu F$, $IR \geq 15000M\Omega$ $C_R > 0.33\mu F$, $IR \geq 5000s$	Measured at $100 \pm 15Vdc$, For 60sec / $25^\circ C$
Capacitance	Within the tolerance specified	1KHz, 1Vrms Max. at $25^\circ C$
Dissipation Factor	0.002 (0.2%) Max.	1Vrms Max. at $25^\circ C$

■ Mark



1. WDC is a registered trademark of WINDAY	2. Capacitance: 205 indicates 2.0μF
3. Capacitors Tolerance: K=±10%	4. Rated Voltage: 700Vdc, Indicates 700
5. MC for Double sided metallized polypropylene film	

SMIT series

■ Typical graphs

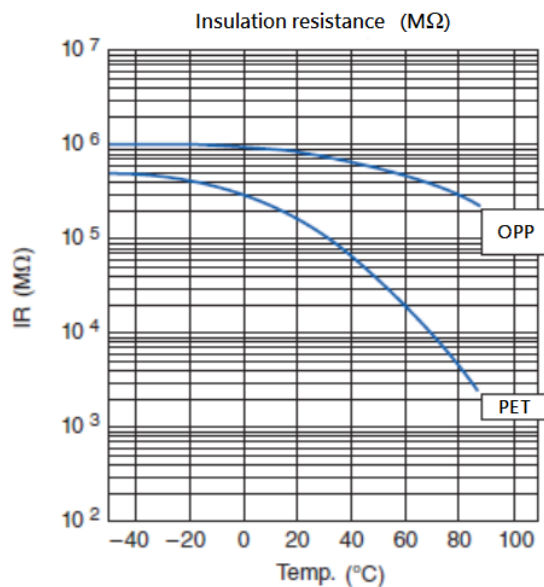
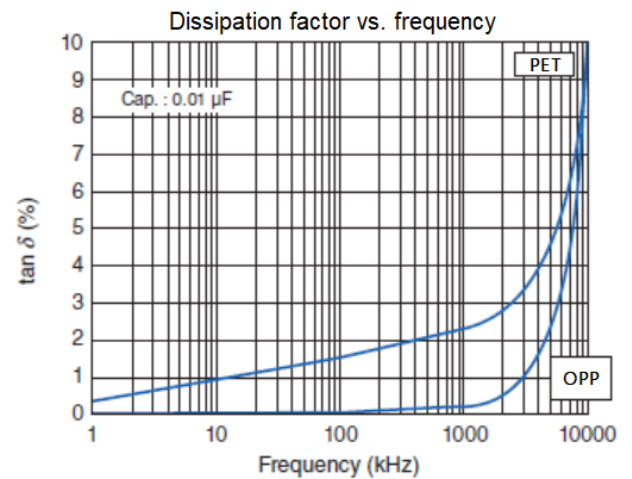
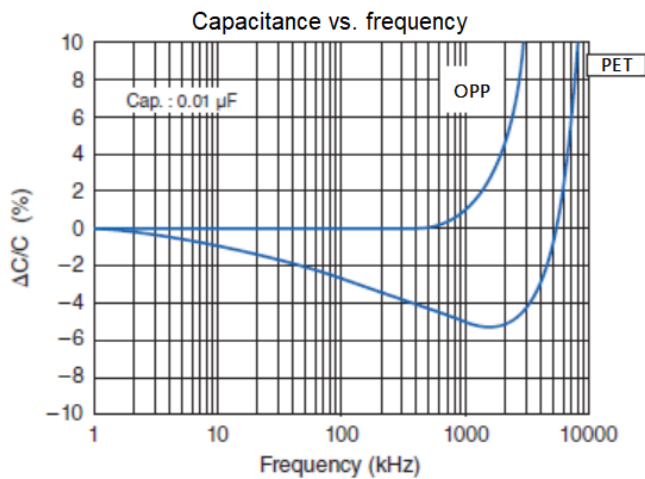
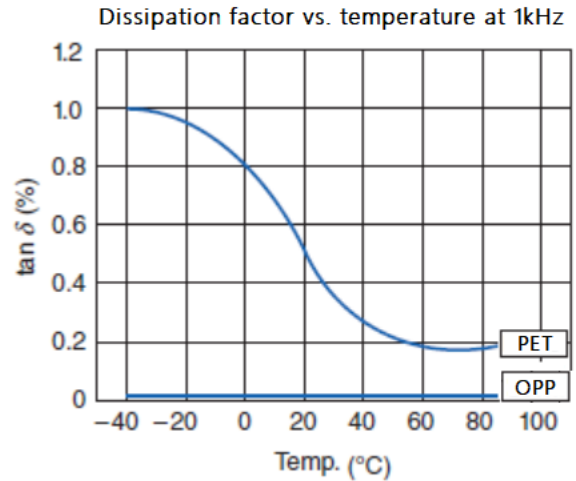
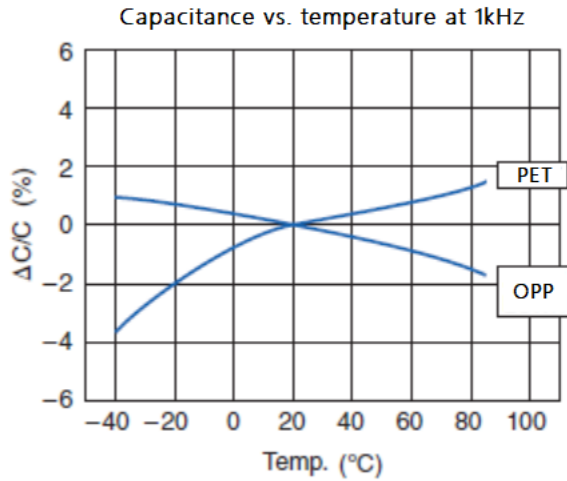

PET :	Metallized Polyester film capacitor
OPP :	Metallized Polypropylene film capacitor

SMIT series

■ Packaging

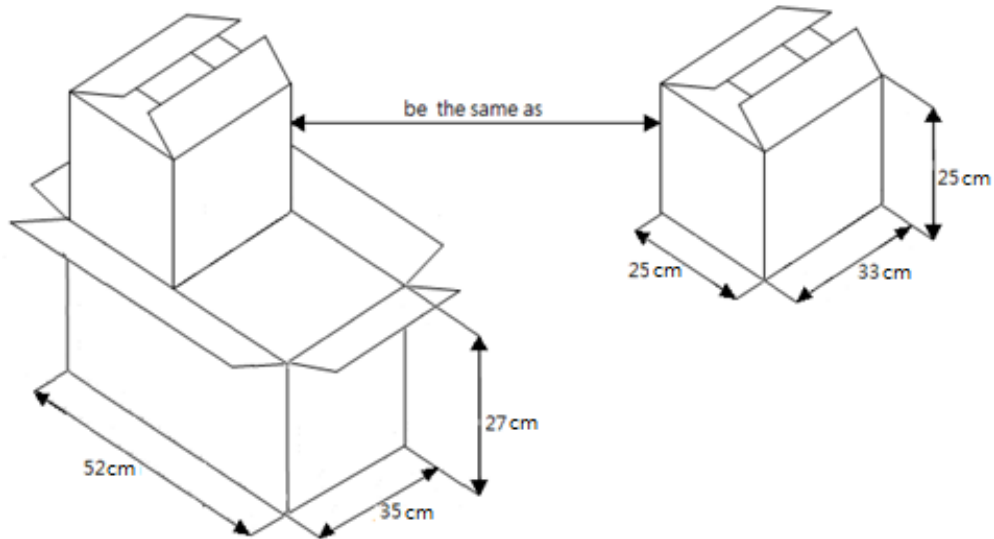

Size (mm)	Pcs / Bag	Pcs / Inner carton (L33:cm XH:25cm X T:25cm)	Pcs / Out box (L52:cm XH:27cm X T:35cm)
18 * 12 * 6	500	5000	10000

■ Storage conditions and duration

Packaged capacitors should be kept in clean, ventilated, dry coffers, not near the heat source, not subject to direct sunlight, is strictly prohibited and chemical reagents, acid and harmful gas storage together.

Capacitor at a temperature within the range 20 ~ 25 °C, humidity less than 50% of the state of storage for one year.